

# Rinnai

## GRADUATE MkII / TITAN MkII GALAXIE MkII / GRANADA MkII

### UNFLUED

with hose

### CUSTOMERS OPERATING INFORMATION AND INSTALLATION INSTRUCTIONS

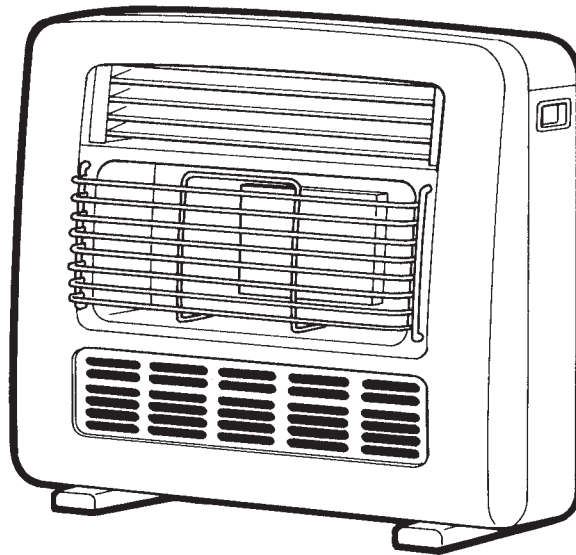

**This appliance shall be installed in accordance with:-**

**Manufacturer's Installation Instructions**

**Local Gas Fitting Regulations**

**Municipal Building Codes**

**A.G.A. Installation Code for Gas Burning Equipment**

**Any other relevant Statutory Regulation**

**This appliance must be installed, serviced and removed by an  
Authorised Person.**



**The Australian  
Gas Association**  
Proudly a member of the AGA  
All of our gas products are AGA  
tested and approved.



**Quality  
Endorsed  
Company**

ISO 9001 Lic 4983  
SAI Global

Head Office Certified

Distributed and serviced in Australia under a Quality  
System certified as complying with ISO 9001 by  
SAI Global

## CONTENTS

Features .....	1
Installation .....	1
Care of your heater .....	2
Guarantee .....	2
Guarantee Information .....	3
Safety Devices .....	3
Important Points .....	4
Pre-Service Check and Fault Finding .....	6
Installation Instructions .....	7
Customers Operating Information .....	8
Specification .....	11
Service Contact Points .....	11

## FEATURES OF YOUR HEATER

1. Fan assisted, radiant/convection flueless space heater.
2. Push button, top mounted control for easy operation.
3. Electronic automatic ignition.
4. Large capacity fan to circulate warm air effectively.
5. Two setting fan control to turn fan on and off and match the fan speed to the heat output.
6. Your heater can be used during a power failure.
7. Flame failure device which cuts the gas off if the flame should be extinguished.
8. Oxygen depletion sensing system which shuts the heater off if the oxygen level in the room falls below a pre-determined level.
9. Jewel cut plaque burner for quick heat up.
10. Complete with 1.5 metre approved gas hose, ready to plug into your bayonet connection.
11. Tilt switch which cuts the gas off if the heater is knocked over.
12. Hose retaining clips and cord storage holder.

## INSTALLATION

The installation of this heater must conform to local regulations. Check with your local gas authority or supplier if you are unsure of the regulations. The room where this heater is installed must be correctly ventilated.

The Titan MkII (REH-151UCH) must not be used in a room smaller than 75 m<sup>3</sup> (W.A. 37.5 m<sup>3</sup>).

The Graduate MkII (REH-181UCH) must not be used in a room smaller than 90 m<sup>3</sup> (W.A. 45 m<sup>3</sup>).

The Galaxie MkII (REH-212UCH) must not be used in a room smaller than 105 m<sup>3</sup> (W.A. 52.5 m<sup>3</sup>).

The Granada MkII (REH-252UCH) must not be used in a room smaller than 125 m<sup>3</sup> (W.A. 62.5 m<sup>3</sup>).

## APPROVAL

Your heater has been approved by the Australian electrical authorities and the Australian Gas Association.

AGA Approval Number 5219.

No parts or functions should be modified, or permanently removed from the heater. Please keep these instructions in a safe place for future reference.

## CARE OF YOUR HEATER

Your heater needs very little maintenance, but the following will help you to keep it looking good and working efficiently.

### ■ Oxygen Depletion Sensor

Annual cleaning of the oxygen depletion sensor is recommended, this should be carried out by Rinnai or our agent.

### ■ Outer Case

The outer case of the heater should be cleaned with a soft, damp cloth. Do not use aerosol polishes to clean the casing whilst the heater is in operation.

Do not connect to an LPG Gas cylinder indoors.  
Do not place articles on or against this appliance.  
Do not use or store flammable materials near this appliance.  
Do not clean plastic parts with solvents; use a soft, damp cloth.  
The guard is fitted to this appliance to reduce the risk of fire or injury from burns and no part of it should be permanently removed.  
For protection of young children or the infirm, a secondary guard is required.

## RINNAI GUARANTEE OF QUALITY

As a purchaser of a high quality Rinnai product we provide you with the following guarantee on your new heater:

	FREE LABOUR PERIOD	FREE PARTS PERIOD
FAN	3 Years	3 Years
COMBUSTION CHAMBER	3 Years	10 Years Pro-rata*
All other parts	3 Years	3 Years

\* Combustion chamber full replacement parts cost in the first 3 years, reducing 15% per year thereafter.

The benefits conferred by this guarantee are in addition to all other rights and remedies in respect of the product which you have under the Trades Practices Act and other State and Territory laws.

**This guarantee does not cover cleaning and normal wear and tear, calls of this nature may be chargeable.**

## GUARANTEE INFORMATION

Please Record below:

Your Retailer:

Address:

Phone:

Date of Purchase:

There is no need to post this guarantee back to Rinnai. Simply keep it in a safe place as your record.

### SERVICE

**RINNAI AUSTRALIA HAS A SERVICE AND SPARE PARTS NETWORK IN ALL STATES. OUR SERVICE NETWORK PERSONNEL ARE FULLY TRAINED AND EQUIPPED TO GIVE THE BEST SERVICE ON YOUR RINNAI APPLIANCE. IF YOUR APPLIANCE NEEDS SERVICE, PLEASE RING ONE OF THE SERVICE CONTACT NUMBERS ON THE BACK OF THIS BOOKLET.**

**RINNAI RECOMMEND THAT THIS APPLIANCE BE SERVICED EVERY 2 YEARS.**

## SAFETY DEVICES

### ■ Oxygen Depletion Sensor

This system turns the heater off if the oxygen level in the room falls below a pre-set level. This can be caused by lack of ventilation, or using the heater in a room which is too small. Before relighting ventilate the room, then follow the ignition procedure. Annual cleaning is recommended, this should be carried out by Rinnai or our agent.

### ■ Flame Failure Device

If the flame goes out during operation, the flame failure device cuts the gas off.

### ■ Fan Switch

The fan switch has two speed settings, and an OFF position. This allows you to choose the best conditions for maximum comfort. The heater may also be used with the fan off.

### ■ Tilt Switch

If the heater is knocked over, the tilt switch will cut off the gas supply. To restore the supply, stand the heater up and follow the ignition procedure. The tilt switch may also operate if heater is jolted or picked up whilst in operation.

# IMPORTANT POINTS

Do not use for any purpose other than heating.

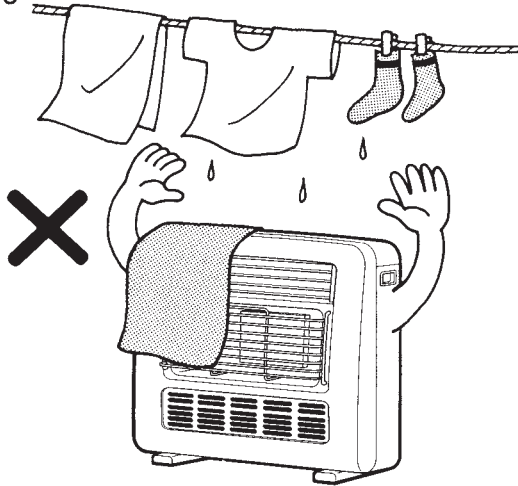

These clearances must be maintained at all times.

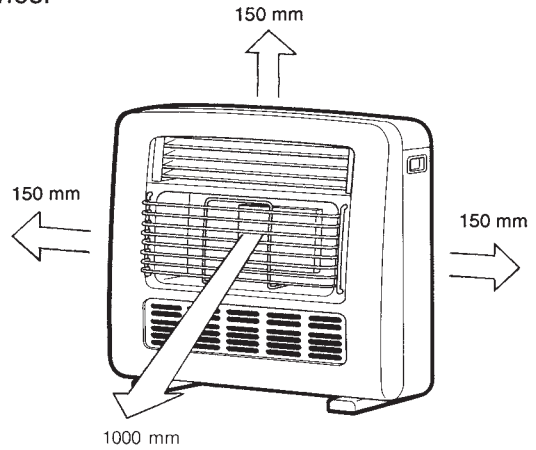

Do not allow curtains or other flammable materials to come into contact with the heater.

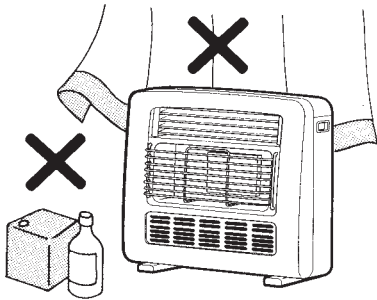

Do not store flammable products near the heater.

Combustible materials must not be placed where the heater could ignite them.

Do not allow young children or the infirm to sleep directly in front of the heater.

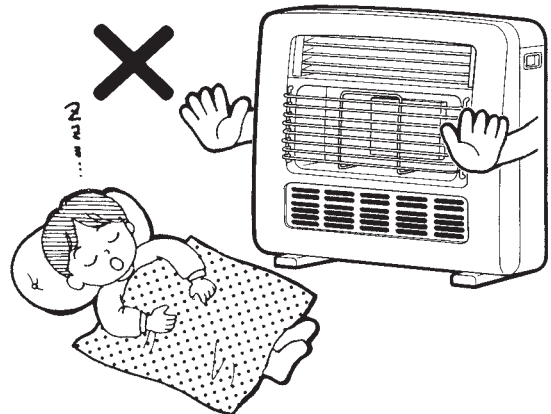

Supervise children near the heater.

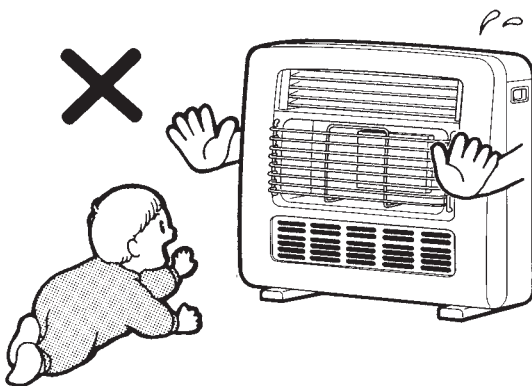

Do not allow children to "post" articles in the louvres.

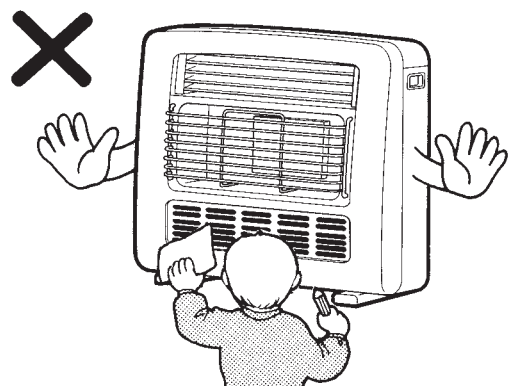

# IMPORTANT POINTS

Do not place any articles containing liquid on top of the heater.

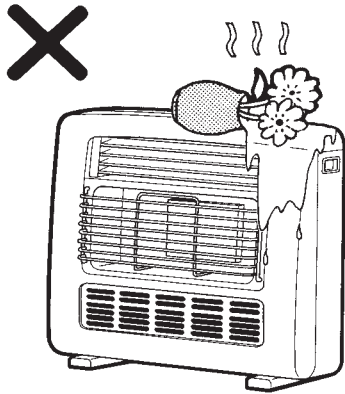

Do not spray aerosols in the vicinity of this heater whilst it is in operation.

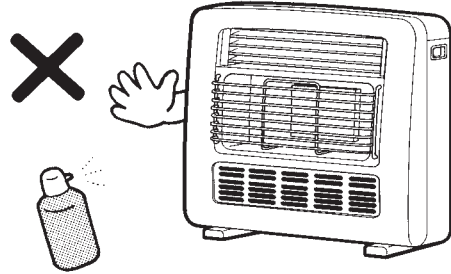

Use of aerosols, paint, polishes, etc., while this heater is in use may cause unpleasant smells. Most aerosols contain butane gas, and can be a fire hazard if used near this heater when it is in use.

Do not sit on this heater.

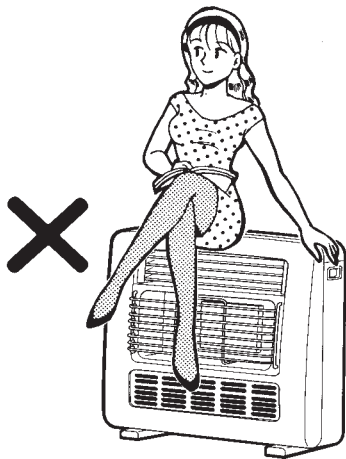

Do not place articles on or against the heater.

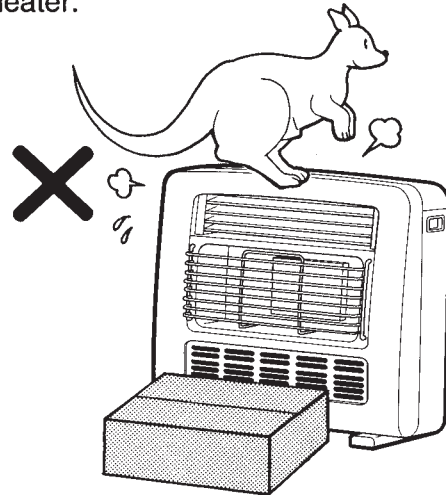

Do not use this heater in areas where spray painting is taking place, or in areas such as hairdressers, where there may be a lot of fluff and dust, and where aerosols may be used.

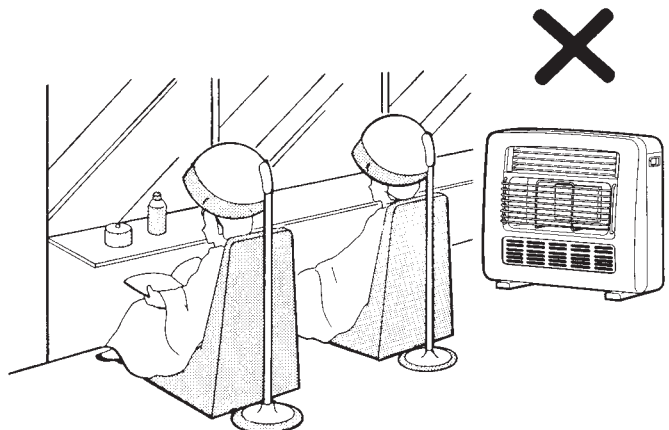

# PRE-SERVICE CHECK LIST AND FAULT FINDING

Please check this fault finding chart before asking for a service call.

You may be able to overcome the problem without a service call, or the heater may be operating normally.

**Service calls to a heater which is operating normally may be chargeable, even when it is under guarantee.**

Problem  Cause	Unit won't ignite	Fan stops when unit is turned off	Takes too long to warm room	Smell of gas	Unit goes out when ign. button is released.	Unit cuts off at all settings	Remedy
Not plugged in at power point	●						Plug in and switch on.
Power cut/failure	●						Investigate cause Allow to cool, re-ignite when power is restored.
Air in gas pipe Initial installation	●						Purge air (installer)
Gas filter blocked	●		●				Service call
Not pushing ignition button firmly enough	●				●		Push button firmly
Louvre obstructed						●	Remove obstruction
Gas escape				●			Turn off gas. Service call
Room too large			●				Check with retailer
Faulty fan			●				Service call
Oxygen depletion system operating						●	Ventilate room
Air in hose	●						Try ignition again
Gas turned off at meter	●						Turn gas on
Automatic fan switch operating		●					Normal operation



# INSTALLATION INSTRUCTIONS

Specifications: See back cover of this instruction booklet.

## ■ UNPACKING

Undo straps, lift carton off heater.

Never lift the heater out of the carton by top louvres. Check for damage, if unit is damaged contact supplier or Rinnai for advice.

## ■ BEFORE USING THE HEATER

Check heater supplied is correct for gas type in your area.  
Refer to local Gas Authority for confirmation of gas type if in doubt.  
Gas type is indicated on the data plate.

Check room size and ventilation

This heater must not be installed in a room smaller than:

REH151UCH (Titan) 75m<sup>3</sup>

REH181UCH (Graduate) 90m<sup>3</sup>

REH212UCH (Galaxie) 105m<sup>3</sup>

REH252UCH (Granada) 125m<sup>3</sup>

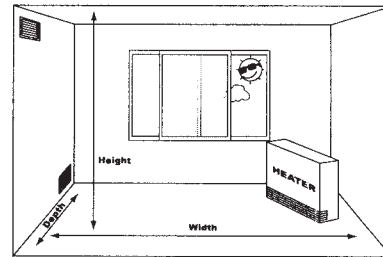

Fixed ventilation must conform to local regulations.

Number and position of vents is for illustrative purposes only. For more information on ventilation, please refer to our Rinnai Web Site [www.rinnai.com.au](http://www.rinnai.com.au)

DO NOT install in a bedroom or bathroom.

The bayonet plug on the factory fitted flexible hose simply plugs into your bayonet fitting.

For the REH151UCH H × W × D must equal or exceed 75.0m<sup>3</sup>

-for example: if room size is L 5.25m × W 6m × H 2.4m the volume will be 75.6m<sup>3</sup>

For the REH181UCH H × W × D must equal or exceed 90.0m<sup>3</sup>

-for example: if room size is L 6.3m × W 6m × H 2.4m the volume will be 90.7m<sup>3</sup>

For the REH212UCH H × W × D must equal or exceed 105.0m<sup>3</sup>

-for example: if room size is L 6.3m × W 7m × H 2.4m the volume will be 105.8m<sup>3</sup>

For the REH252UCH H × W × D must equal or exceed 125.0m<sup>3</sup>

-for example: if room size is L 7.5m × W 7m × H 2.4m the volume will be 126.0m<sup>3</sup>

This heater must not be installed where curtains or other combustible materials could come into contact with it.

In some cases curtains may need restraining.

Other clearances are shown in the diagram.

This heater is not designed to be built in bookcases or shelves.

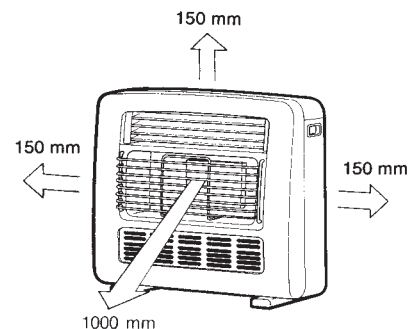

An EARTHED power point, and bayonet gas connection must be close enough to where the heater will be used to avoid stretching the connection.

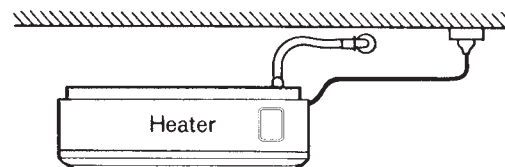

**AFTER INSTALLATION CHECKS HAVE BEEN COMPLETED**

Connect gas and power → Follow ignition instructions



# CUSTOMERS OPERATING INFORMATION

For trouble free operation, please read the following information carefully.

For your convenience, the controls on your heater are situated under the cover on the top right hand side of the heater.

All necessary adjustments to the operation of your heater can be made with these controls.

## CONNECT GAS AND PLUG INTO POWER POINT

### IGNITION

Room must be ventilated when this heater is in use.

Press the front control button firmly, this operates the built in safety device and starts the electronic spark, the centre burner will ignite. Check that the burner has lit, continue to hold the button down for about 15 seconds. The spark will continue whilst the button is held down.

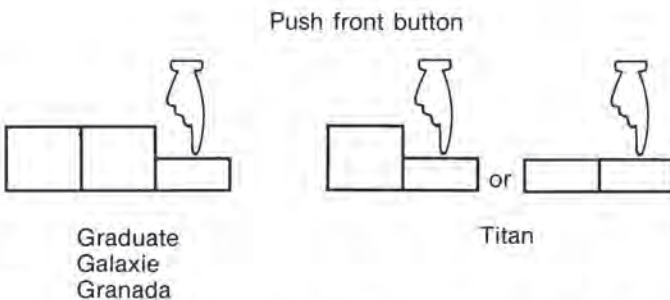

### CONTROL BOX

GRANADA  
GALAXIE  
GRADUATE

TITAN

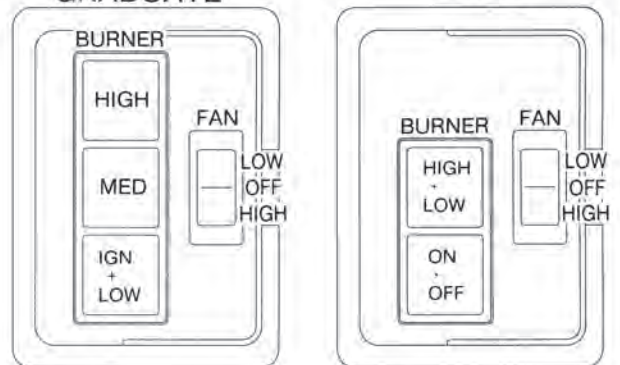

The Titan high burner control button may be in either position for ignition.

### Note

If the burner does not remain alight, push the button again and release it, this will return it to the "OFF" position. Wait 30 seconds, then repeat the ignition procedure.

(The ignition button must be in the "OFF" position before attempting re-ignition).

The burner should glow evenly after a few minutes of operation. If there is a large difference in the glow, or there is an unusual amount of flame coming from the top of the burner, contact your agent or Rinnai. Graduate burners shown here.

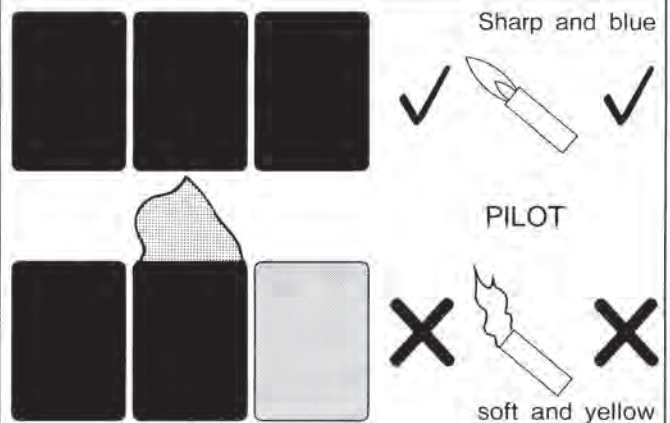

# CUSTOMERS OPERATING INFORMATION

## ■ TO INCREASE THE HEAT

Press the control buttons in order from front to rear, this will ignite additional burners as shown in the diagram.

There is no need to hold the buttons for 15 seconds when increasing the heat.

## ■ TO DECREASE THE HEAT

This is simply done by releasing the control buttons in order from rear to front, to the required setting.

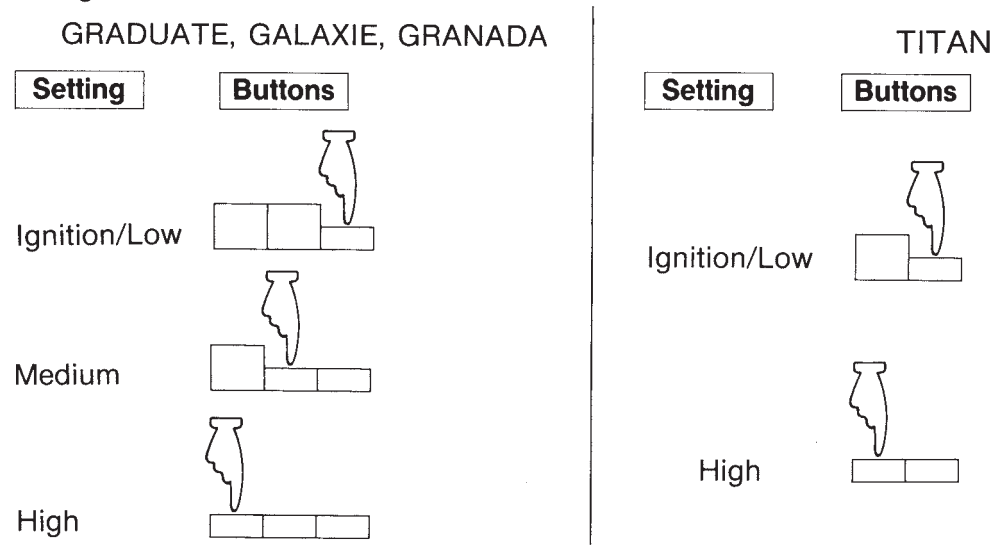

Burner Settings (MJ/h)			
	LOW	MEDIUM	HIGH
Titan	7	—	Natural 15   Propane 14
Graduate	6	12	18
Galaxie	7	14	21
Granada	8	16	25

# FAN

The fan switch has two speed settings, and an OFF position. This allows you to choose the best conditions for maximum comfort.

If the fan switch is in the HIGH or LOW position, the fan starts automatically when the heater is alight. When the heater is turned off, the fan stops automatically, there is no need to return the manual fan switch to the off position each time the heater is turned off.

## TO TURN THE HEATER OFF

Press and release the front button.  
Ensure all burners are extinguished.

# WIRING DIAGRAM

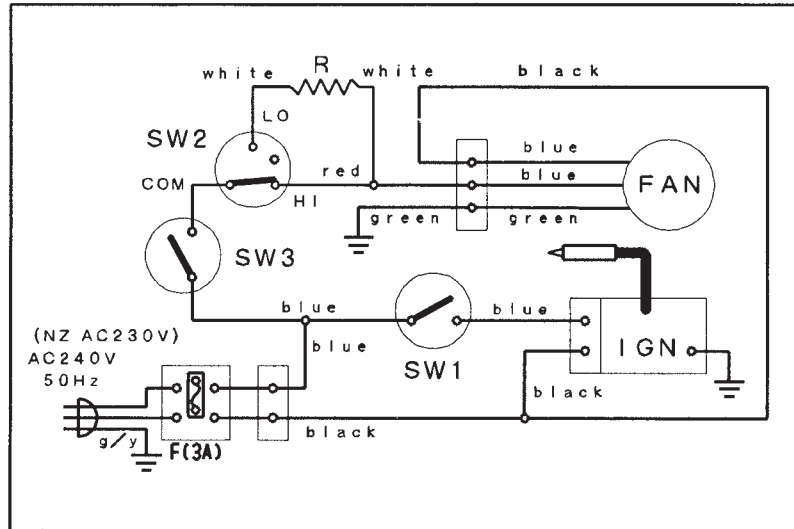

\* Supply lead must only be replaced with Rinnai part number 90174772.

# DIMENSIONS

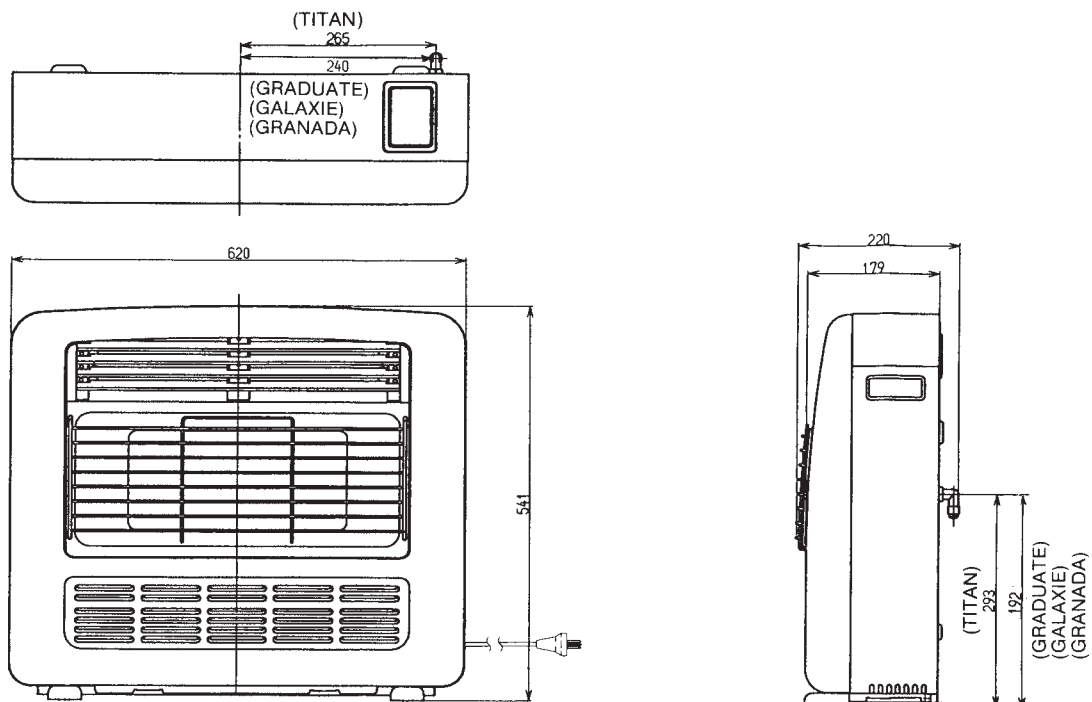

## SPECIFICATIONS

Description:	REH-151UCH (TITAN MkII WITH HOSE) REH-181UCH (GRADUATE MkII WITH HOSE) REH-212UCH (GALAXIE MkII WITH HOSE) REH-252UCH (GRANADA MkII WITH HOSE) Rinnai Radiant/forced convection, open fronted, surface combustion flueless space heater.
Input:	TITAN MkII (REH-151UCH) Propane 14 MJ/h / Natural 15 MJ/h GRADUATE MkII (REH-181UCH) 18 MJ/h GALAXIE MkII (REH-212UCH ) 21 MJ/h GRANADA MkII (REH-252UCH) 25 MJ/h
Gas Control:	Rinnai Push Button Combination Control
Burner:	Rinnai Jewel Cut Plaque
Gas Inlet:	Supplied with approved 1.5 m Hose
Ignition:	Electronic
Oxygen Depletion System:	Rinnai ODS Pilot
Power Supply:	240 V 50 Hz, heater is supplied with 3 pin plug and supply lead, replace only with Rinnai part number 90174772.
Fan:	Tangential 2 speed, 24 Watt Rating.
Data Plate:	Rear, near the gas connection.

Rinnai are continually updating and improving products, therefore specifications are subject to change without prior notice.

## SERVICE CONTACT POINTS

# Rinnai

Rinnai Australia Pty. Ltd.  
ACN 005 138 769  
ABN 74 005 138 769

10-11 Walker Street  
Braeside VIC 3195

**☎ Helpline : 1300 366 388**

Sales / Service: Facsimile : (03) 9271 6611

Mon-Fri (8.30am to 5.30pm EST)

Cost of a local call. Higher from mobile or public phones.

Internet : [www.rinnai.com.au](http://www.rinnai.com.au)

email : [enquiry@rinnai.com.au](mailto:enquiry@rinnai.com.au)



110609

Rinnai Australia Pty. Ltd. Reserves the right to make  
modifications and change specifications without notice.

Printed in Japan  
REH151-94X07(00)  
06.12